

Facelift Fair & Square

LOUNGE / TANDEM / BENCHES / TABLES

Effective: August 1, 2022

T R I N I T Y

Date:

Page:

Modification:

Description:

DESCRIPTION:

- Upholstery Frames: Plywood & Hardwood
- Seat: High Density Polyurethane Foam Over Sheet Webbing
- Upholstered Covers: Attached w/ Velcro / Removable For Maintenance
- Antimicrobial Moisture Barrier Fully Encapsulates All Foam Areas
- Ganging Straps Standard
- Brushed Aluminum Round Legs / Removable For Maintenance
- Leather Upholstery Is Available
- Lifetime Warranty

OPTIONS:

- USB-1 USB In Back (2 Ports Available - Specify Left or Right Facing).....\$185
- Feather Down & Polyester Pillows Available (See Page 5)

NOTE: Additional Seaming May Be Required If Fabric Is Railroaded.

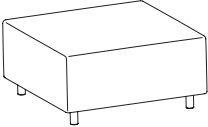
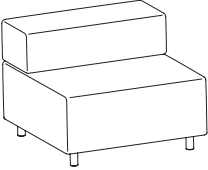
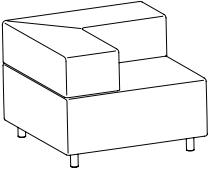
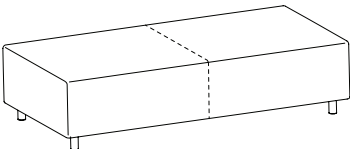
TANDEM	ITEM #:	SPECIFICATIONS GRADES LIST PRICES:													
		Overall: 36"w 36"d 18"h		Arm: n/a		COM: 2.5 yds.									
		Seat: 36"w 36"d 18"h		Weight: 62 lbs.		COL: 45 sq.ft.									
		COM	COL	1	2	3	4	5	6	7	8	9	10	L1	L2
	1550	1001	1101	1138	1235	1331	1427	1523	1619	1716	1812	1908	2004	2094	2441
		<i>Tight Seat / Removable Upholstery</i>													
	1550-R	117	129	234	296	358	420	482	544	605	667	729	791	848	1070
		<i>Replacement Upholstery Covers</i>													
		Overall: 36"w 36"d 28"h		Arm: n/a		COM: 3.25 yds.									
		Seat: 36"w 22"d 18"h		Weight: 70 lbs.		COL: 59 sq.ft.									
		COM	COL	1	2	3	4	5	6	7	8	9	10	L1	L2
	1551	1392	1531	1481	1563	1646	1728	1811	1893	1976	2058	2140	2223	2312	2609
		<i>Tight Seat & Back / Removable Upholstery</i>													
	1551-R	160	176	316	399	481	564	646	729	811	894	976	1059	1134	1431
		<i>Replacement Upholstery Covers</i>													
		Overall: 36"w 36"d 28"h		Arm: n/a		COM: 4 yds.									
		Seat: 36"w 22"d 18"h		Weight: 74 lbs.		COL: 72 sq.ft.									
		COM	COL	1	2	3	4	5	6	7	8	9	10	L1	L2
	1552	1593	1752	1712	1815	1918	2022	2125	2228	2331	2434	2537	2640	2754	3125
		<i>Tight Seat & Back / Removable Upholstery</i>													
	1552-R	211	232	406	509	612	715	818	921	1024	1127	1231	1334	1431	1802
		<i>Replacement Upholstery Covers</i>													
		Overall: 72"w 36"d 18"h		Arm: n/a		COM: 4.5 yds.									
		Seat: 72"w 36"d 18"h		Weight: 121 lbs.		COL: 81 sq.ft.									
		COM	COL	1	2	3	4	5	6	7	8	9	10	L1	L2
	1555	1452	1597	1606	1723	1840	1957	2074	2191	2307	2424	2541	2658	2771	3191
		<i>Tight Seat / Removable Upholstery</i>													
	1555-R	181	199	404	521	638	755	872	989	1105	1222	1339	1456	1554	1975
		<i>Replacement Upholstery Covers</i>													

DESCRIPTION:

- Upholstery Frames: Plywood & Hardwood
- Seat: High Density Polyurethane Foam Over Sheet Webbing
- Upholstered Covers: Attached w/ Velcro / Removable For Maintenance
- Antimicrobial Moisture Barrier Fully Encapsulates All Foam Areas
- Ganging Straps Standard
- Brushed Aluminum Round Legs / Removable For Maintenance
- Leather Upholstery Is Available
- Lifetime Warranty

OPTIONS:

- USB-1 USB In Back (2 Ports Available - Specify Left or Right Facing).....\$185
- Feather Down & Polyester Pillows Available (See Page 5)

NOTE: Additional Seaming May Be Required If Fabric Is Railroaded.

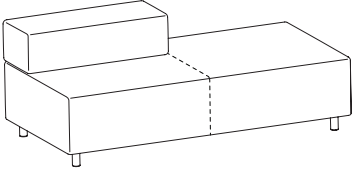
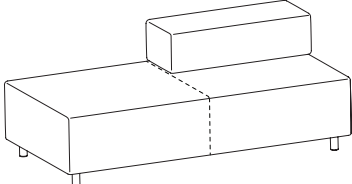
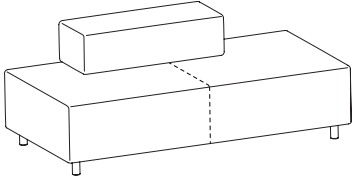
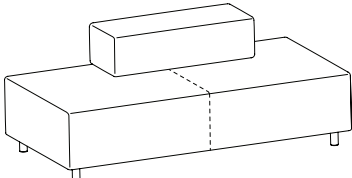
TANDEM		ITEM #:	SPECIFICATIONS GRADES LIST PRICES:													
			Overall: 72"w 36"d 28"h			Arm: n/a			COM: 5.25 yds.							
			Seat: 72"w 22"/36"d 18"h			Weight: 129 lbs.			COL: 95 sq.ft.							
			COM	COL	1	2	3	4	5	6	7	8	9	10	L1	L2
	1556		1964	2161	2132	2270	2407	2545	2682	2819	2957	3094	3232	3369	3508	4002
			<i>Tight Seat & Back / Removable Upholstery</i>													
	1556-R		236	260	498	635	773	910	1048	1185	1323	1460	1598	1735	1853	2348
			<i>Replacement Upholstery Covers</i>													
			Overall: 72"w 36"d 28"h			Arm: n/a			COM: 5.25 yds.							
			Seat: 72"w 22"/36"d 18"h			Weight: 129 lbs.			COL: 95 sq.ft.							
			COM	COL	1	2	3	4	5	6	7	8	9	10	L1	L2
	1557		1964	2161	2132	2270	2407	2545	2682	2819	2957	3094	3232	3369	3508	4002
			<i>Tight Seat & Back / Removable Upholstery</i>													
	1557-R		236	260	498	635	773	910	1048	1185	1323	1460	1598	1735	1853	2348
			<i>Replacement Upholstery Covers</i>													
			Overall: 72"w 36"d 28"h			Arm: n/a			COM: 5.25 yds.							
			Seat: 72"w 22"d 18"h			Weight: 129 lbs.			COL: 95 sq.ft.							
			COM	COL	1	2	3	4	5	6	7	8	9	10	L1	L2
	1558		1970	2167	2138	2275	2413	2550	2687	2825	2962	3100	3237	3375	3513	4008
			<i>Tight Seat & Back / Removable Upholstery</i>													
	1558-R		236	260	498	635	773	910	1048	1185	1323	1460	1598	1735	1853	2348
			<i>Replacement Upholstery Covers</i>													
			Overall: 72"w 36"d 28"h			Arm: n/a			COM: 5.25 yds.							
			Seat: 72"w 22"d 18"h			Weight: 129 lbs.			COL: 95 sq.ft.							
			COM	COL	1	2	3	4	5	6	7	8	9	10	L1	L2
	1559		1970	2167	2138	2275	2413	2550	2687	2825	2962	3100	3237	3375	3513	4008
			<i>Tight Seat & Back / Removable Upholstery</i>													
	1559-R		236	260	498	635	773	910	1048	1185	1323	1460	1598	1735	1853	2348
			<i>Replacement Upholstery Covers</i>													

DESCRIPTION:

- Upholstery Frames: Plywood & Hardwood
- Seat: High Density Polyurethane Foam Over Sheet Webbing
- Upholstered Covers: Attached w/ Velcro / Removable For Maintenance
- Antimicrobial Moisture Barrier Fully Encapsulates All Foam Areas
- Ganging Straps Standard
- Brushed Aluminum Round Legs / Removable For Maintenance
- Leather Upholstery Is Available
- Lifetime Warranty

OPTIONS:

- USB-1 USB In Back (2 Ports Available - Specify Left or Right Facing).....\$185
- Feather Down & Polyester Pillows Available (See Page 5)

NOTE: Additional Seaming May Be Required If Fabric Is Railroaded.

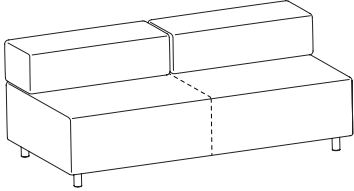
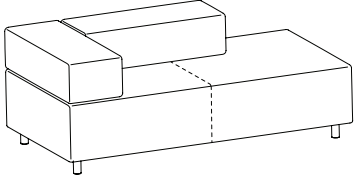
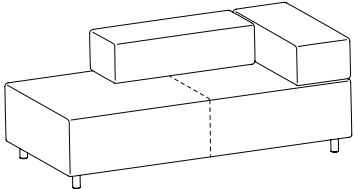
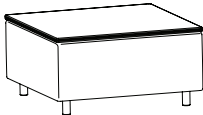
TANDEM		ITEM #:	SPECIFICATIONS GRADES LIST PRICES:													
			Overall: 72"w 36"d 28"h			Arm: n/a			COM: 6 yds.							
			Seat: 72"w 22"d 18"h			Weight: 137 lbs.			COL: 108 sq.ft.							
			COM	COL	1	2	3	4	5	6	7	8	9	10	L1	L2
	1560		2323	2556	2513	2671	2829	2987	3145	3303	3461	3619	3777	3935	4112	4681
			<i>Tight Seat & Back / Removable Upholstery</i>													
	1560-R		256	281	558	716	874	1032	1190	1348	1506	1664	1822	1980	2118	2687
			<i>Replacement Upholstery Covers</i>													
			Overall: 72"w 36"d 28"h			Arm: n/a			COM: 6 yds.							
			Seat: 72"w 22"/36"d 18"h			Weight: 137 lbs.			COL: 108 sq.ft.							
			COM	COL	1	2	3	4	5	6	7	8	9	10	L1	L2
	1561		2358	2594	2546	2704	2862	3020	3178	3336	3494	3652	3810	3968	4145	4714
			<i>Tight Seat & Back / Removable Upholstery</i>													
	1561-R		256	281	558	716	874	1032	1190	1348	1506	1664	1822	1980	2118	2687
			<i>Replacement Upholstery Covers</i>													
			Overall: 72"w 36"d 28"h			Arm: n/a			COM: 6 yds.							
			Seat: 72"w 22"/36"d 18"h			Weight: 137 lbs.			COL: 108 sq.ft.							
			COM	COL	1	2	3	4	5	6	7	8	9	10	L1	L2
	1562		2358	2594	2546	2704	2862	3020	3178	3336	3494	3652	3810	3968	4145	4714
			<i>Tight Seat & Back / Removable Upholstery</i>													
	1562-R		256	281	558	716	874	1032	1190	1348	1506	1664	1822	1980	2118	2687
			<i>Replacement Upholstery Covers</i>													
			Overall: 36"w 36"d 19"h			Arm: n/a			COM: 2.25 yds.							
			Seat: n/a			Weight: 103 lbs.			COL: 41 sq.ft.							
			COM	COL	1	2	3	4	5	6	7	8	9	10	L1	L2
	1564-L		1437	1580	1468	1523	1578	1633	1688	1743	1798	1853	1908	1963	2024	2222
			<i>High Pressure Laminate Face / Multi-Ply Edge</i>													
	1564-R		117	129	234	296	358	420	482	544	605	667	729	791	848	1070
			<i>Replacement Upholstery Covers</i>													

DESCRIPTION:

- High Pressure Laminate Face
- Multi-Ply Edge
- Lifetime Warranty

OPTIONS:

Specify Laminate (See Page 6)

TANDEM	ITEM #:	SPECIFICATIONS GRADES LIST PRICES:																										
<p>TABLE TOP ONLY / CAN BE SUBSTITUTED FOR ANY BACK</p> 		<p>Overall: 36"w 14"d 1"h Seat: n/a</p>	<p>Arm: n/a Weight: 16 lbs.</p>	<p>COM: n/a COL: n/a</p>																								
		<table border="1"> <thead> <tr> <th>COM</th> <th>COL</th> <th>1</th> <th>2</th> <th>3</th> <th>4</th> <th>5</th> <th>6</th> <th>7</th> <th>8</th> <th>9</th> <th>10</th> <th>L1</th> <th>L2</th> </tr> </thead> <tbody> <tr> <td colspan="14" style="text-align: center;">229 <i>High Pressure Laminate Face / Multi-Ply Edge</i></td> </tr> </tbody> </table>	COM	COL	1	2	3	4	5	6	7	8	9	10	L1	L2	229 <i>High Pressure Laminate Face / Multi-Ply Edge</i>											
COM	COL	1	2	3	4	5	6	7	8	9	10	L1	L2															
229 <i>High Pressure Laminate Face / Multi-Ply Edge</i>																												

Configuration Examples

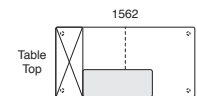
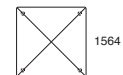
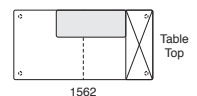
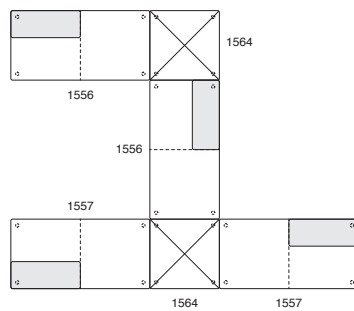
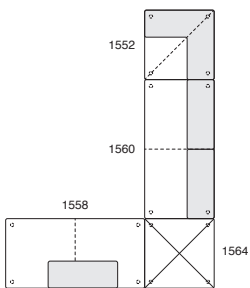
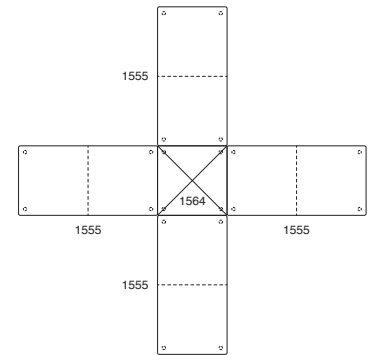
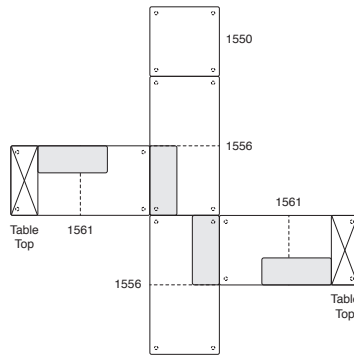
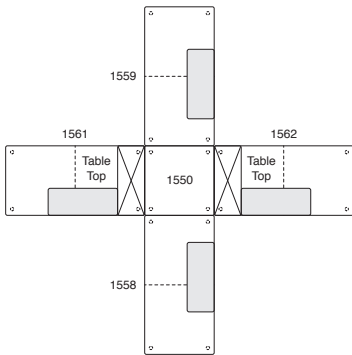
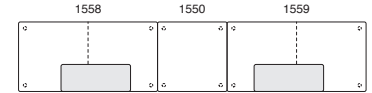
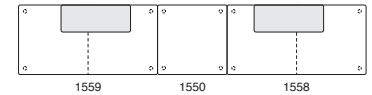
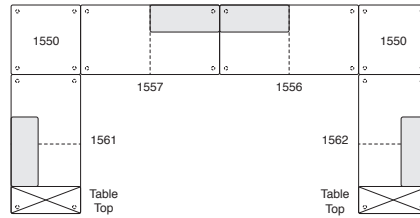
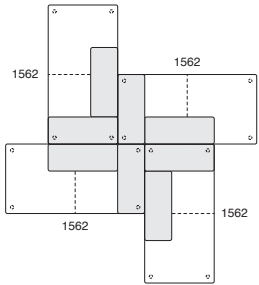
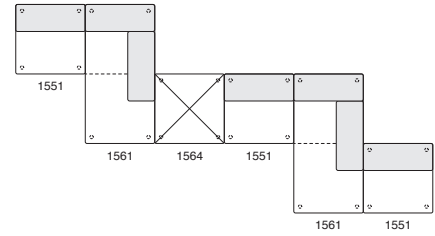
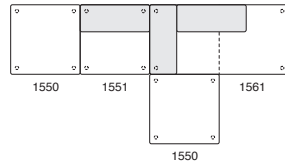
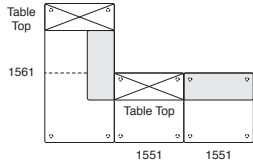

POWER / COVERS	OPTION #:	SPECIFICATIONS LIST PRICES AVAILABILITY:
<p>DUAL CHARGING USB</p> 	<p>USB-1</p>	<p><i>Overall: 2"w 2"d .1875"h</i></p> <hr/> <p>\$185 (Per Arm) <i>Spill-Proof Technology / 2 Amps Per Port / Multiple Finish Options / Storm Color Standard (Specify Left or Right Facing)</i></p> <p><i>Available: Facelift Fair & Square Collection</i></p>
<p>CONTRASTING COVERS</p> 	<p>CC</p>	<p><i>Overall: N/A</i></p> <hr/> <p>\$129 <i>NOTE: If Two Or More Upholsteries Or Leathers Are Used On Any Piece Of Furniture, Then A Contrast Charge Will Apply Per Order. When Using Trinity Upholstery, The Higher Priced Upholstery Grade Will Be Used In Pricing, Unless It's Trinity Leather With Fabric Contrast Welt, Or COM With Trinity Contrast Welt, Then Contact Customer Service For Pricing.</i></p> <p><i>Available: Facelift Fair & Square Collection</i></p>